



上海川源机械工程有限公司
Shanghai GSD Industrial Co.,Ltd



HRB

高效率三叶罗茨鼓风机

HRB high efficiency three-lobe roots blower



HRB 高效率三叶罗茨鼓风机

HRB high efficiency three-lobe roots blower

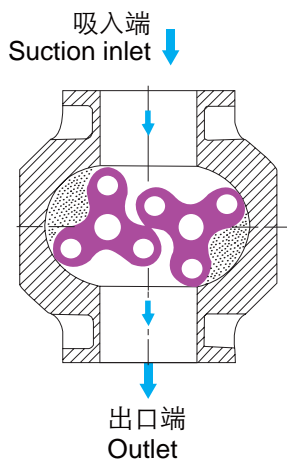

原理 Theory

HRB三叶罗茨风机是一种容积式风机，其压力可根据用户的要求在允许的范围内加以调节，在机壳内部设置有两组互朝相反方向回轮的叶轮，在叶轮与叶轮，及叶轮与壳体间仅留极小缝隙的状态下回转。当叶轮经过吸入端时，与壳体之间捕捉一定量的空气，随叶轮旋转，空气移动，压力逐渐升高再送至出口端。

HRB is a displacement blower, the pressure can be adjusted according to the requirement of the user in allowing range. There are two impellers in the blower body which rotate in the opposite direction, in order to let the impeller rotate, there are some tiny gaps between the impeller and body, impeller and impeller. When the impeller rotates through the suction inlet, it can gather an amount of air between the body and impeller, then the impeller go on rotating, and the air will be pressured, the pressure in the body will rise, finally the air has been sent to the outlet.

特点 Features

HRB系列三叶罗茨鼓风机是在GRB基础上，进行了一系列研究发展起来的。该风机最大的特点是高转速（最高可达4000RPM），高容量。通过技术的突破和不断在实践中优化，HRB系列具有更高的效率，更高的压力和较轻的重量。进气口尺寸从2.5"至12"。单台风机的压力可达到1Kgf/cm²。

- 高效率
优秀的线性设计，减少转子截面积，以提高鼓风机的效率。
- 低振动
高平衡精度（G2.5）级可以控制的X，Y，Z轴振动坐标。
- 低损耗压力
180度的入口和出口之间的垂直结构，减少压力损失。

HRB series 3-lobe roots blowers are researched and developed on a basis of GRB series. The biggest feature of this blower is high rotation speed (the maximum can be 4000 RPM), high capacity. With the break-through of technology and the modification of practical application, HRB series blowers have higher efficiency, higher pressure and lower weight. The inlet sizes are from 2.5" to 12". The pressure of single blower can be 1 Kgf/cm².

- High efficiency
Great liner structure, reduce sectional area of rotors to improve capacity of blowers.
- Low vibration
High grade of balance accuracy (G2.5) can control the vibration of X, Y, Z coordinate.
- Low loss of pressure
180 degrees vertical structure between inlet and outlet, reduce its pressure loss of blowers.

外形结构图 Externality construction

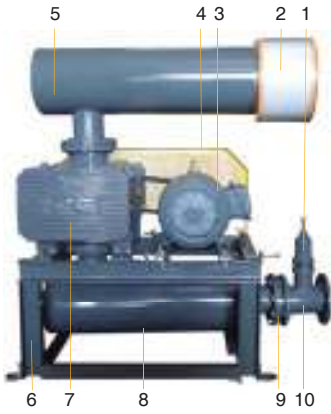

NO.	名称	NAME
1	安全阀	Safety value
2	过滤器	Filter barrel
3	电机	Motor
4	防雨罩	Hood
5	入口消音器	Inlet silencer
6	底座	Bottom case
7	本体	Main body
8	出口消音器	Outlet silencer
9	逆止阀	Check valve
10	三通管	T-joint

型号说明 Type description

HRB - 65

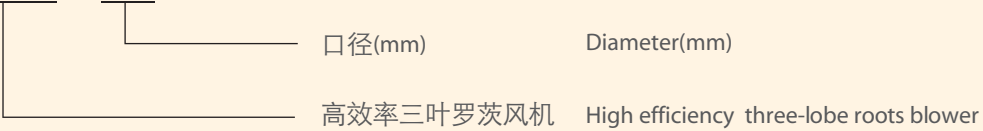

结构简图 Construction

NO.	名称	NAME	材质 MATERIAL
1	油箱	Oil box	HT250
2	风机脚	Foot	Q235
3	轴承座	Bearing housing	HT250
4	机体	Casing	HT250
5	齿轮箱	Gear box	HT250
6	加油螺栓	lubrication plug	45
7	润滑油面计	Oil gauge	组合件
8	泄油螺栓	Purge plug	45
9	被动叶轮	Driven rotor	组合件
10	主动叶轮	Drive rotor	组合件
11	甩油片	Oil splash	Q235
12	轴承固定片	Bearing washer	Q235
13	活塞环	Piston ring	HT-200
14	骨架油封	Framework oil seal	VTION
15	轴承	Bearing	SUJ2
16	齿轮	Gear	20GrMnTi
17	止动垫圈	Lock washer	Q235
18	止动螺母	Lock nut	45

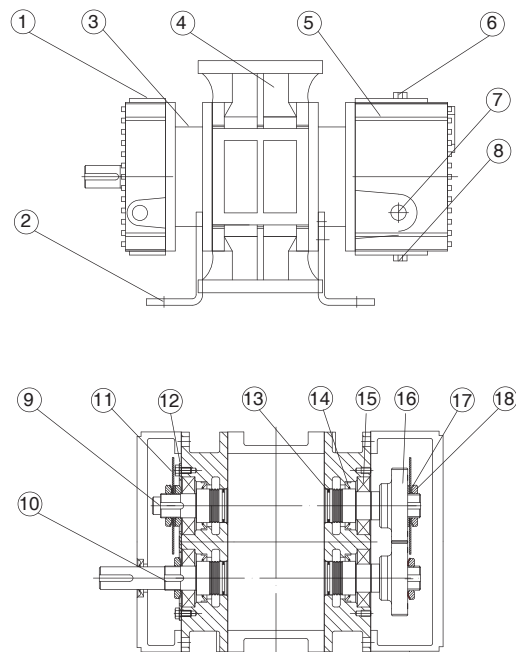

单位换算表 Conversion table

PRESSURE	atm	kPa	bar	lbt/in ² (psi)	kgf/cm ²	in Hg	ftAq	mmHg(Torr)	mmAq
1 atm	1	101.325	1.01325	14.696	1.0333	29.921	33.914	760	10333
1 kPa	0.0099	1	0.01	0.145	0.0102	0.295	0.335	7.5	102
1 bar	0.9869	100	1	14.504	1.0198	29.53	33.47	750	10198
1 lbt/in ² (psi)	0.068	6.894	0.0689	1	0.0703	2.036	2.308	51.71	703
1 kgf/cm ²	0.968	98.062	0.981	14.228	1	28.96	32.82	735.53	10000
1 inHg	0.0334	3.3863	0.0339	0.491	0.0345	1	1.133	25.4	345.3
1 ftAq	0.0295	2.99	0.0299	0.434	0.0305	0.882	1	22.42	304.8
1 mmHg(Torr)	0.013	0.1338	0.00138	0.019	0.0014	0.04	0.045	1	13.6
1 mmAq	0.00097	0.0098	0.00098	0.0014	0.0001	0.003	0.0033	0.074	1

CAPACITY	m ³ /min	l/min	cm ³ /s	in ³ /s	ft ³ /min(cfm)
1 m ³ /min	1	1000	16667	1016	35.288
1 l/min	0.001	1	16.67	1.02	0.0353
1 cm ³ /s	0.00006	0.06	1	0.061	0.02
1 in ³ /s	0.00098	0.983	16.39	1	0.035
1 ft ³ /min(cfm)	0.028	28.32	471.95	28.8	1

压力常用换算公式

Pressure Conversion Formula

1 kPa=1000Pa=1000N/m²

1mbar=10.198mmAq

1mmHg(Torr)=133.8Pa

性能表使用须知 Working directions of performance table

- 性能参数表示鼓风机之型式、口径、回转数、吐出压力、实际进口风量、轴动力。
- 性能参数为标准吸入状态之空气量(温度20℃，绝对压力1.0332kgf/cm²，相对湿度65%)。
- 基准状态(温度0℃，绝对压力1.0332kgf/cm²)的风量，一般以Nm³/min表示。
- 不同状态进口风量的换算：

$$Q_2 = Q_1 \times \frac{P_1}{P_2} \times \frac{273+T_2}{273+T_1}$$

Q₁: 绝对压力P₁(mmAq) 摄氏温度T₁(°C)状态的风量(m³/min)

Q₂: 绝对压力P₂(mmAq) 摄氏温度T₂(°C)状态的风量(m³/min)

- 电机功率一般为轴功率的1.1~1.3倍。
- 性能参数误差约5%。

- The performance parameter indicate the type, caliber, revolutions, discharge pressure, actual inlet air capacity and shaft power of the blower.
- The performance parameter indicate the air quantity in standard suction condition (temperature 20°C, absolute pressure 1.0332 kgf/cm² and relative humidity 65%) .
- The reference air capacity (temperature 0°C and absolute pressure 1.0332kgf/cm²) is generally indicated in Nm³/min.
- The inlet air capacity can be converted as following.

$$Q_2 = Q_1 \times \frac{P_1}{P_2} \times \frac{273+T_2}{273+T_1}$$

Q₁: Air capacity (m³/min) based on absolute pressure P₁(mmAq) and temperature T₁(°C)

Q₂: Air capacity (m³/min) based on absolute pressure P₂(mmAq) and temperature T₂(°C)

- The motor power is 1.1~1.3 multiple of shaft power.
- The error of the parameter is about 5%.



性能参数 Performance parameters

Qs(m³/min) Pressure(mmAq) La (kW)

型号 Type	转速 RPM	1000mmAq		2000mmAq		3000mmAq		4000mmAq		5000mmAq		6000mmAq		7000mmAq		8000mmAq		9000mmAq		10000mmAq	
		Qs	La	Qs	La	Qs	La	Qs	La	Qs	La	Qs	La	Qs	La	Qs	La	Qs	La	Qs	La
HRB-200	1470	34.56	6.33	33.96	12.66	33.42	18.99	32.91	25.32	32.40	31.65	31.91	37.99	31.44	44.32	30.98	50.65	30.54	56.98	30.12	63.31
	1560	36.74	6.72	36.15	13.44	35.61	20.16	35.09	26.87	34.59	33.59	34.10	40.31	33.62	47.03	33.16	53.75	32.72	60.47	32.31	67.18
	1650	38.92	7.11	38.33	14.21	37.79	21.32	37.27	28.42	36.77	35.53	36.28	42.64	35.80	49.74	35.35	56.85	34.91	63.95	34.49	71.06
	1750	41.35	7.54	40.75	15.07	40.21	22.61	39.70	30.15	39.19	37.68	38.71	45.22	38.23	52.76	37.77	60.29	37.33	67.83	36.92	75.37
	1850	43.77	7.97	43.18	15.93	42.64	23.90	42.12	31.87	41.62	39.84	41.13	47.80	40.66	55.77	40.20	63.74	39.76	71.71	39.34	79.67
	1950	46.20	8.40	45.61	16.80	45.07	25.19	44.55	33.59	44.05	41.99	43.56	50.39	43.08	58.79	42.62	67.18	42.19	75.58	41.77	83.98
	2050	48.63	8.83	48.03	17.66	47.49	26.49	46.97	35.32	46.47	44.14	45.98	52.97	45.51	61.80	45.05	70.63	44.61	79.46	44.19	88.29
	2150	51.05	9.26	50.46	18.52	49.92	27.78	49.40	37.04	48.90	46.30	48.41	55.56	47.93	64.82	47.48	74.08	47.04	83.33	46.62	92.59
	2250	53.48	9.69	52.88	19.38	52.34	29.07	51.83	38.76	51.32	48.45	50.83	58.14	50.36	67.83	49.90	77.52	49.46	87.21	49.05	96.90
	2350	55.90	10.12	55.31	20.24	54.77	30.36	54.25	40.48	53.75	50.60	53.26	60.72	52.79	70.85	52.33	80.97	51.89	91.09	51.47	101.21
	2450	58.33	10.55	57.74	21.10	57.20	31.65	56.68	42.21	56.18	52.76	55.69	63.31	55.21	73.86	54.75	84.41	54.31	94.96	53.90	105.51
	2550	60.76	10.98	60.16	21.96	59.62	32.95	59.10	43.93	58.60	54.91	58.11	65.89	57.64	76.87	57.18	87.86	56.74	98.84	56.32	109.82
	2650	63.18	11.41	62.59	22.83	62.05	34.24	61.53	45.65	61.03	57.06	60.54	68.48	60.06	79.89	59.60	91.30	59.17	102.72	58.75	114.13
HRB-250	1320	60.55	11.20	59.18	22.40	57.94	33.60	56.74	44.80	55.58	56.00	54.45	67.19	53.34	78.39	52.27	89.59	51.24	100.79	50.26	111.99
	1390	63.89	11.79	62.53	23.59	61.28	35.38	60.09	47.17	58.93	58.96	57.79	70.76	56.69	82.55	55.62	94.34	54.59	106.14	53.61	117.93
	1480	68.20	12.56	66.83	25.11	65.59	37.67	64.39	50.23	63.23	62.78	62.09	75.34	60.99	87.90	59.92	100.45	58.89	113.01	57.91	125.57
	1560	72.02	13.24	70.65	26.47	69.41	39.71	68.21	52.94	67.05	66.18	65.91	79.41	64.81	92.65	63.74	105.88	62.71	119.12	61.73	132.35
	1650	76.32	14.00	74.95	28.00	73.71	42.00	72.51	56.00	71.35	69.99	70.22	83.99	69.11	97.99	68.04	111.99	67.01	125.99	66.03	139.99
	1750	81.10	14.85	79.73	29.69	78.49	44.54	77.29	59.39	76.13	74.24	74.99	89.08	73.89	103.93	72.82	118.78	71.79	133.63	70.81	148.47
	1850	85.88	15.70	84.51	31.39	83.27	47.09	82.07	62.78	80.91	78.48	79.77	94.17	78.67	109.87	77.60	125.57	76.57	141.26	75.59	156.96
	1950	90.66	16.54	89.29	33.09	88.05	49.63	86.85	66.18	85.69	82.72	84.55	99.26	83.45	115.81	82.38	132.35	81.35	148.90	80.37	165.44
	2050	95.43	17.39	94.07	34.78	92.82	52.18	91.63	69.57	90.47	86.96	89.33	104.35	88.23	121.75	87.16	139.14	86.13	156.53	85.15	173.92
	2150	100.21	18.24	98.85	36.48	97.60	54.72	96.41	72.96	95.25	91.20	94.11	109.45	93.00	127.69	91.93	145.93	90.91	164.17	89.92	182.41
HRB-300	1050	92.14	16.89	90.54	33.77	89.09	50.66	87.70	67.54	86.34	84.43	85.03	101.31	83.75	118.20	82.52	135.08	81.34	151.97	80.21	168.86
	1110	97.58	17.85	95.98	35.70	94.52	53.55	93.13	71.40	91.78	89.25	90.46	107.10	89.18	124.95	87.95	142.80	86.77	160.65	85.65	178.50
	1180	103.92	18.98	102.32	37.95	100.86	56.93	99.47	75.90	98.12	94.88	96.80	113.86	95.52	132.83	94.29	151.81	93.11	170.79	91.99	189.76
	1250	110.26	20.10	108.66	40.20	107.21	60.31	105.81	80.41	104.46	100.51	103.14	120.61	101.87	140.71	100.63	160.81	99.45	180.92	98.33	201.02
	1320	116.60	21.23	115.00	42.46	113.55	63.68	112.15	84.91	110.80	106.14	109.48	127.37	108.21	148.59	106.97	169.82	105.79	191.05	104.67	212.28
	1390	122.94	22.35	121.34	44.71	119.89	67.06	118.49	89.41	117.14	111.77	115.82	134.12	114.55	156.47	113.31	178.83	112.13	201.18	111.01	223.53
	1480	131.09	23.80	129.49	47.60	128.04	71.40	126.65	95.20	125.29	119.00	123.98	142.80	122.70	166.60	121.47	190.40	120.29	214.21	119.16	238.01
	1560	138.34	25.09	136.74	50.17	135.29	75.26	133.89	100.35	132.54	125.44	131.22	150.52	129.95	175.61	128.71	200.70	127.53	225.78	126.41	250.87
	1650	146.49	26.53	144.89	53.07	143.44	79.60	142.05	106.14	140.69	132.67	139.38	159.21	138.10	185.74	136.86	212.28	135.68	238.81	134.56	265.34
	1750	155.55	28.14	153.95	56.29	152.50	84.43	151.10	112.57	149.75	140.71	148.43	168.86	147.16	197.00	145.92	225.14	144.74	253.28	143.62	281.43
1850	164.61	29.75	163.01	59.50	161.55	89.25	160.16	119.00	158.81	148.75	157.49	178.50	156.21	208.26	154.98	238.01	153.80	267.76	152.68	297.51	



外形尺寸图 Installation dimensions

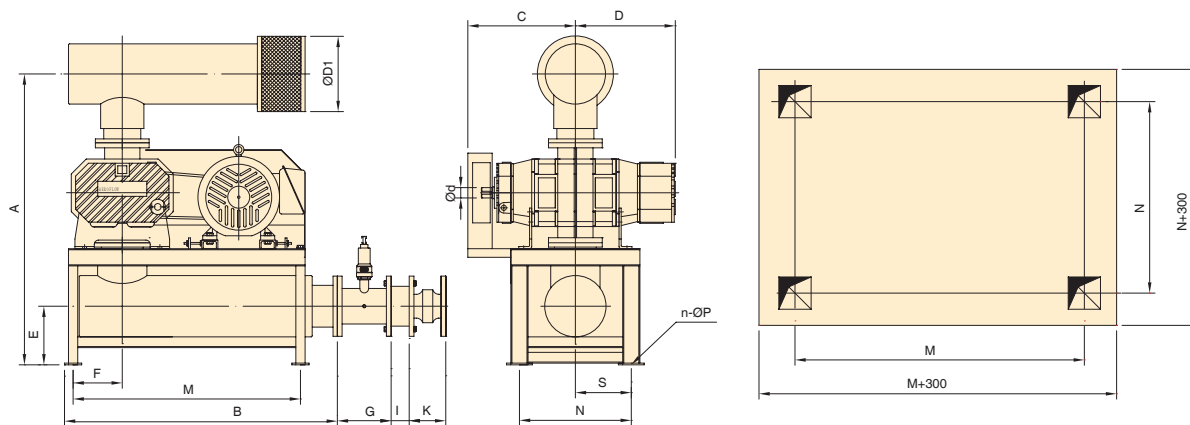

单位: (mm)

型号 Type	A	B	C	D	D1	E	F	S	G	I	K	M	N	d	n-ØP
HRB-65	910	750	260	242	200	180	80	297	150	24	115	560	420	28	4-Ø18
HRB-80	950	1000	300	282	250	170	151	215	180	24	135	840	450	28	4-Ø18
HRB-100	1100	1150	380	285	280	197	182	240	180	24	150	950	450	38	4-Ø18
HRB-125	1150	1250	405	310	320	192	218.5	265	250	25	165	1100	500	38	4-Ø18
HRB-150	1310	1250	440	404	350	230	228.5	360	250	26	180	1100	560	48	4-Ø18
HRB-200	1580	1520	560	445	450	305	240	322	250	28	190	1250	640	60	4-Ø22
HRB-250	1760	1465	620	502	500	280	235	400	250	28	230	1250	760	65	4-Ø22
HRB-300	1910	1980	900	590	500	310	380	447.5	300	181	250	1800	810	80	4-Ø22

安全阀 Safety valve

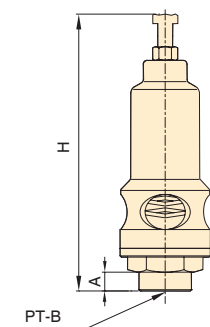

单位: (mm)

型号 Type	A	H	适用机型 Application type	重量 Weight (kg)
SV1 1/4"	25	150	HRB-65, 80	1.6
SV2"	25	180	HRB-100, 125, 150	2.5
SV3"	30	250	HRB-200	5.0
SV4"	25	316	HRB-250, 300	8.5

入口消音器 Suction silencer

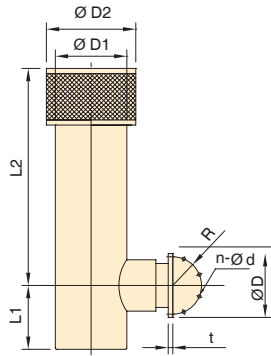

单位: (mm)

型号 Type	D	t	n	d	r	D1	D2	H	L1	L2
HRB-65	185	16	4	19	72.5	165.2	200	240	120	580
HRB-80	200	16	8	19	80	216.7	250	260	150	650
HRB-100	220	16	8	19	90	240	280	280	180	720
HRB-125	250	18	8	19	105	280	320	320	200	800
HRB-150	285	20	8	23	120	300	350	320	250	850
HRB-200	340	20	8	23	147.5	400	450	360	300	900
HRB-250	395	22	12	23	175	450	500	400	300	1000
HRB-300	445	22	12	23	200	450	500	400	350	1050

出口消音器 Outlet silencer

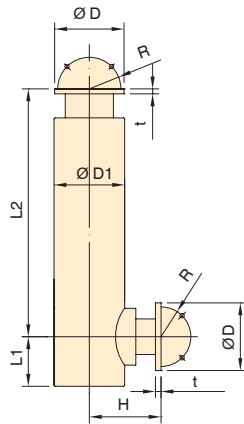

单位: (mm)

型号 Type	D	t	n	d	r	D1	H	L1	L2
HRB-65	185	16	4	19	72.5	165.2	215	200	800
HRB-80	200	16	8	19	80	165.2	230	200	900
HRB-100	220	16	8	19	90	219	245	200	900
HRB-125	250	18	8	19	105	219	260	200	1000
HRB-150	285	20	8	23	120	285	295	200	1000
HRB-200	340	20	8	23	147.5	345	365	200	1100
HRB-250	395	22	12	23	175	400	400	250	1150
HRB-300	445	22	12	23	200	450	450	250	1250

三通管 "T"-joint

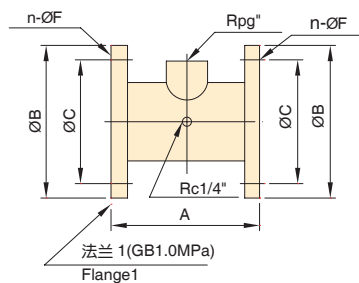

单位: (mm)

型号 Type	A	ØB	ØC	n-ØF	g	重量 Weight (kg)	适用型号 Application type
HJ65	150	185	145	4-Ø18	1 1/4	9.0	HRB-65
HJ80	180	200	160	8-Ø18	1 1/4	9.6	HRB-80
HJ100	180	220	180	8-Ø18	2	10.7	HRB-100
HJ125	250	250	210	8-Ø18	2	14.5	HRB-125
HJ150	250	285	240	8-Ø22	2	20.8	HRB-150
HJ200	250	340	295	8-Ø22	3	26.0	HRB-200
HJ250	250	395	350	12-Ø22	3	35.0	HRB-250
HJ300	300	445	400	12-Ø22	3	44.7	HRB-300



地脚螺栓 Anchor bolt

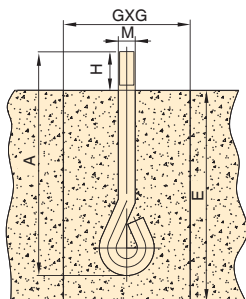

单位: (mm)

地脚螺栓M Anchor bolt GB799-88	A	H	E	GxG	适用型号 Application type
M12	160	36	224	100×100	HRB-65, 80
M16	220	45	275	120×120	HRB-100, 125, 150
M20	300	55	345	150×150	HRB-200, 250, 300

注: 1. 图注E为最小尺寸, 根据安装的土壤情况, 应适当加深。
2. GxG为二次浇灌前的预留孔尺寸。

Note: 1. The note E on the drawing is the minimum size, it shall be deepened properly according to the soil condition in the installation place.
2. GxG is the size of the preformed holes for the secondary casting.

弹性接头 Series resilient connector

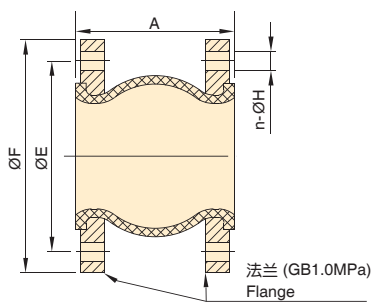

单位: (mm)

型号 Type	A	ØE	ØF	n-ØH	重量 Weight (kg)	适用型号 Application type
KXT65	115	145	185	4-Ø18	3.5	HRB-65
KXT80	135	160	200	8-Ø18	4.0	HRB-80
KXT100	150	180	220	8-Ø18	5.0	HRB-100
KXT125	165	210	250	8-Ø18	6.5	HRB-125
KXT150	180	240	285	8-Ø22	9.5	HRB-150
KXT200	190	295	340	8-Ø22	16.0	HRB-200
KXT250	230	350	395	12-Ø22	25.0	HRB-250
KXT300	250	400	445	12-Ø22	42.0	HRB-300

逆止阀 Check valve

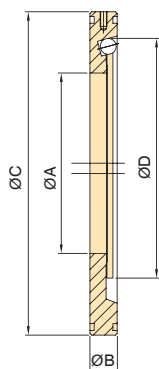



单位: (mm)

型号 Type	ØA	B	ØC	ØD	重量 Weight (kg)	适用型号 Application type
DCV-65	36	24	124	65.9	1.4	HRB-65
DCV-80	46	24	134	78.1	1.6	HRB-80
DCV-100	67	24	159	102.3	2.3	HRB-100
DCV-125	88	25	190	126.6	3.4	HRB-125
DCV-150	108	26	220	151	5.0	HRB-150
DCV-200	138	28	270	200	10.0	HRB-200
DCV-250	185	28	335	251.4	18.0	HRB-250
DCV-300	-	181	380	300	48.0	HRB-300

注: DCV-300型为双瓣式逆止阀, 结构略有不同

Note: DCV-300 is the double flap type check valve, so it's a little difference from others.

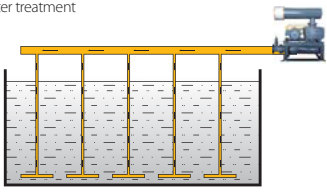
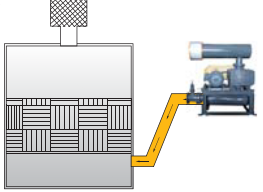
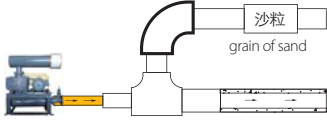
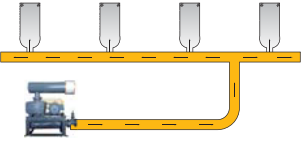
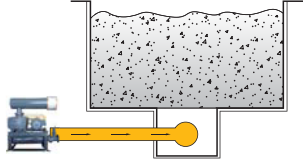
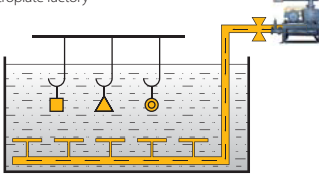
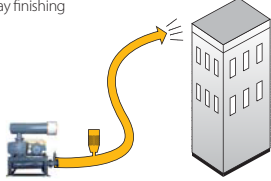
用途说明 Applications

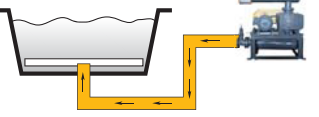
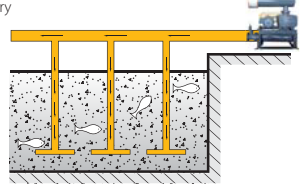
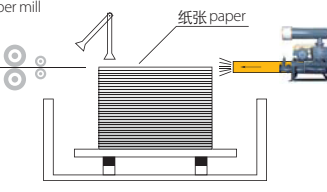
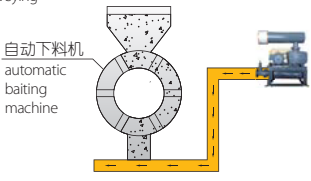
<p>水处理 Water treatment</p>  <p>1 用于污水处理厂的曝气处理 Aeration of sewage</p>	<p>燃烧炉 Incinerator</p>  <p>5 用于助燃，增加氧气促进燃烧 Used for combustion, increasing oxygen to promote combustion</p>	<p>管路清理 Pipe clearing</p>  <p>9 通过气体吹动沙子或硬质颗粒来冲刷管路 Use gas blowing sand to flush pipes</p>
<p>啤酒厂、饮料行业 Brewery and beverage industry</p>  <p>2 用于气体运动将瓶内死角清理干净 Clean up the bottle's dead angle by gas</p>	<p>发酵厂 Fermenting plant</p>  <p>6 通过增含氧量，来促进发酵 Increasing oxygen to promote the fermentation</p>	<p>电镀行业 Electroplate factory</p>  <p>10 利用气体使液体均匀化，液体与工件充分接触 Stir gas liquid, make its uniformity</p>
<p>喷涂 Spray finishing</p>  <p>3 通过气体将防火材料喷涂到墙上或钢筋结构上 Use gas spraying fire-resistant material on the wall</p>	<p>洗车 Car washing</p>  <p>7 洗车厂通过虹吸现象带动洗车液清洗车辆 Use washing fluid washing car base on siphon principle</p>	<p>桑拿 Sauna</p>  <p>11 做人体按摩，促进血液循环 Do body massage, promote the blood circulation</p>
<p>养殖场 Fishery</p>  <p>4 养殖场中增加水中氧气 Increasing oxygen in water</p>	<p>造纸厂 Paper mill</p>  <p>8 纸张被吹起后，机械手臂使其搬运 The mechanical arm carries the paper after it has been rised by the wind</p>	<p>物料输送 Conveying</p>  <p>12 利用气体运动将物料输送 Use gas conveying materials</p>



欢迎索取以下产品型录



泵系列

- 潜水泵系列
- 陆上泵系列
- 特种泵系列
- 消防泵系列



搅拌推流系列

- 搅拌机系列
- 推流器系列



供氧曝气系列

- 曝气机系列
- 曝气盘系列
- 曝气管系列



风机系列

- 三叶罗茨鼓风机系列
- 增压罗茨鼓风机系列



污泥处理设备 及其他

- 固液分离系列
- 泡药设备
- 输送设备



上海川源机械工程有限公司
Shanghai GSD Industrial Co., Ltd

免费咨询电话

800-820-1977

本型录内容如有变更，恕不另行通知。
We reserve the right to change content without notice.